

Front Headliner**Special Tool(s) / General Equipment**

Interior Trim Remover

Materials

Name	Specification
3M™ Super-Fast Repair Adhesive 04747	-

Removal

NOTE: Removal steps in this procedure may contain installation details.

1. On both sides.
Remove the A-pillar trim panel.
Refer to: [A-Pillar Trim Panel](#) (501-05 Interior Trim and Ornamentation, Removal and Installation).
2. **NOTE:** *RH side shown, LH side similar.*
 1. On both sides.
Remove the D-ring covers.
 2. On both sides.
Remove the D-ring bolts.
Torque: 30 lb.ft (40 Nm)

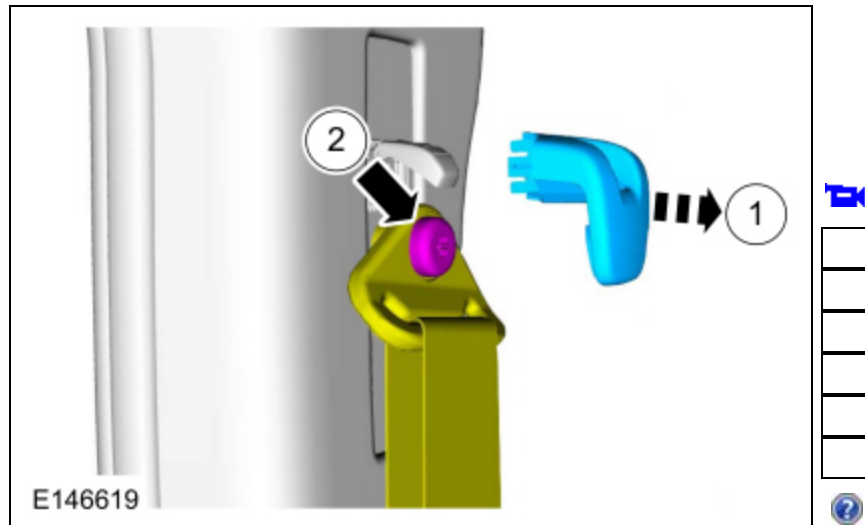

3. **NOTE:** *M2 bus shown, all other vehicles similar.*

Release the clips and remove the driver side middle B-pillar trim panel.

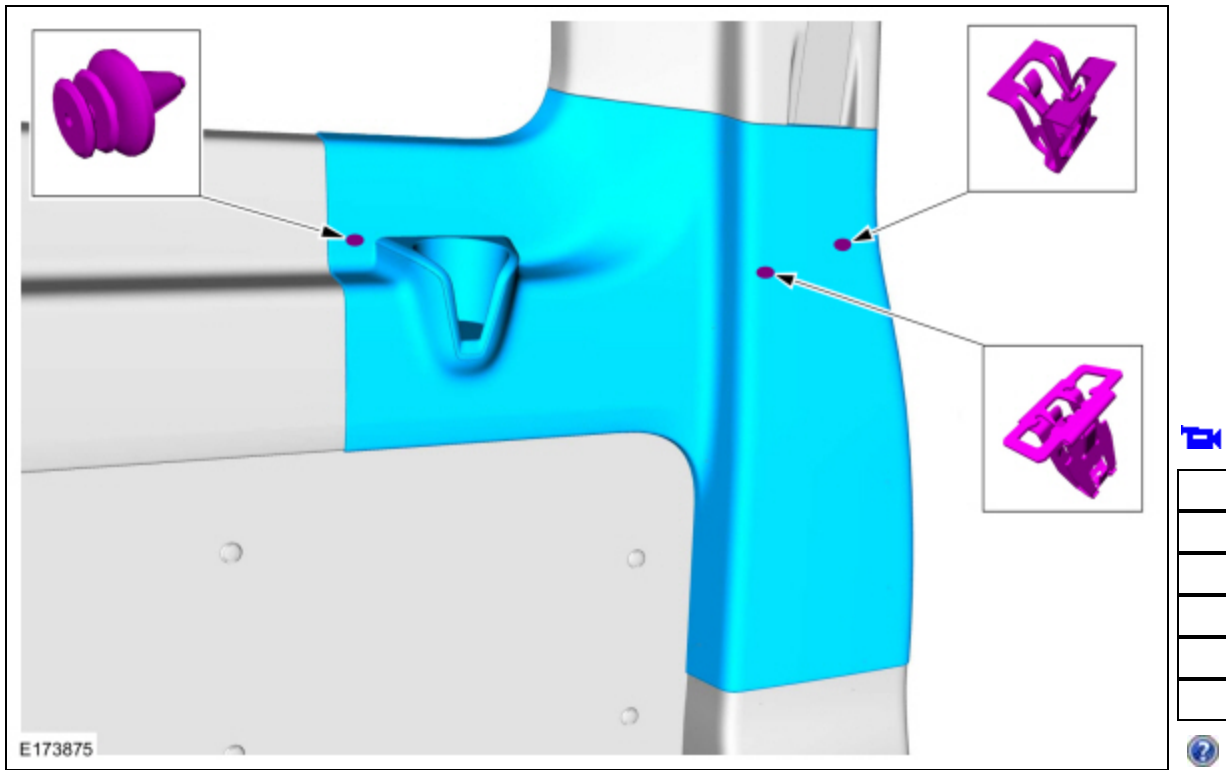

4. Release the clips and remove the passenger side assist handle bolt covers.

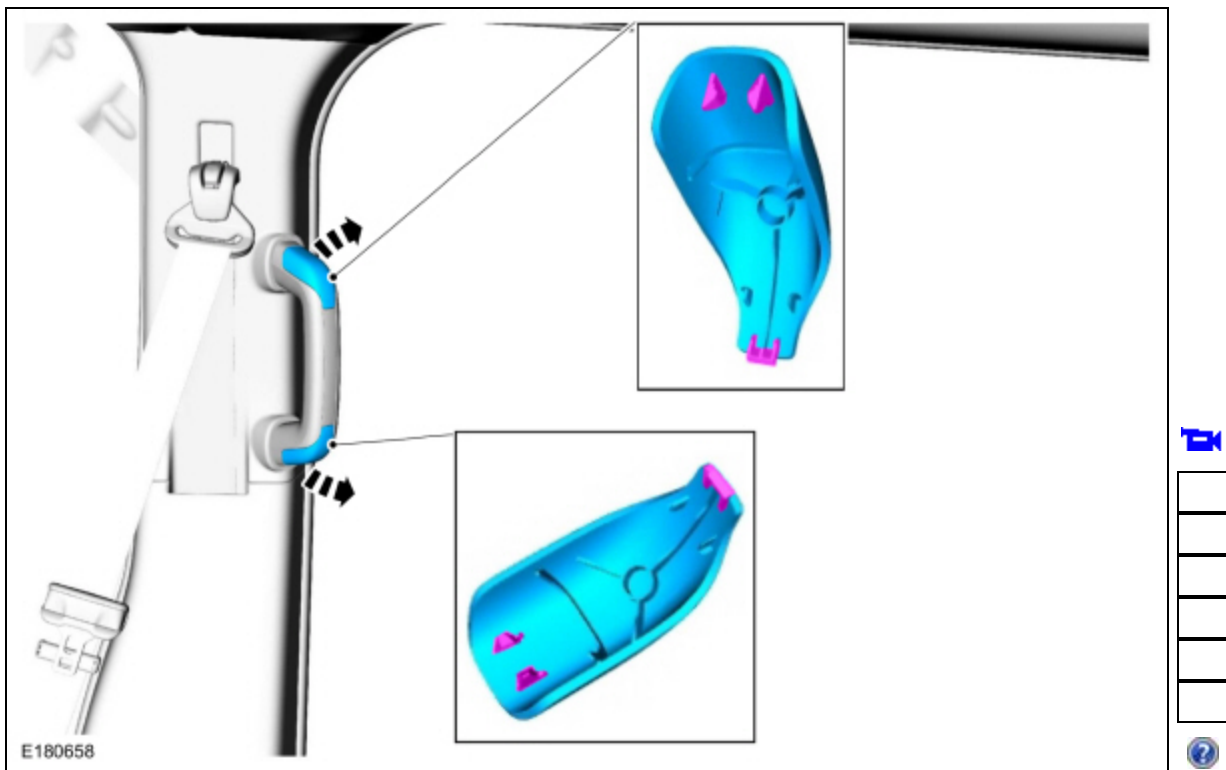

5. Remove the bolts and the passenger side assist handle.
Torque: 93 lb.in (10.5 Nm)

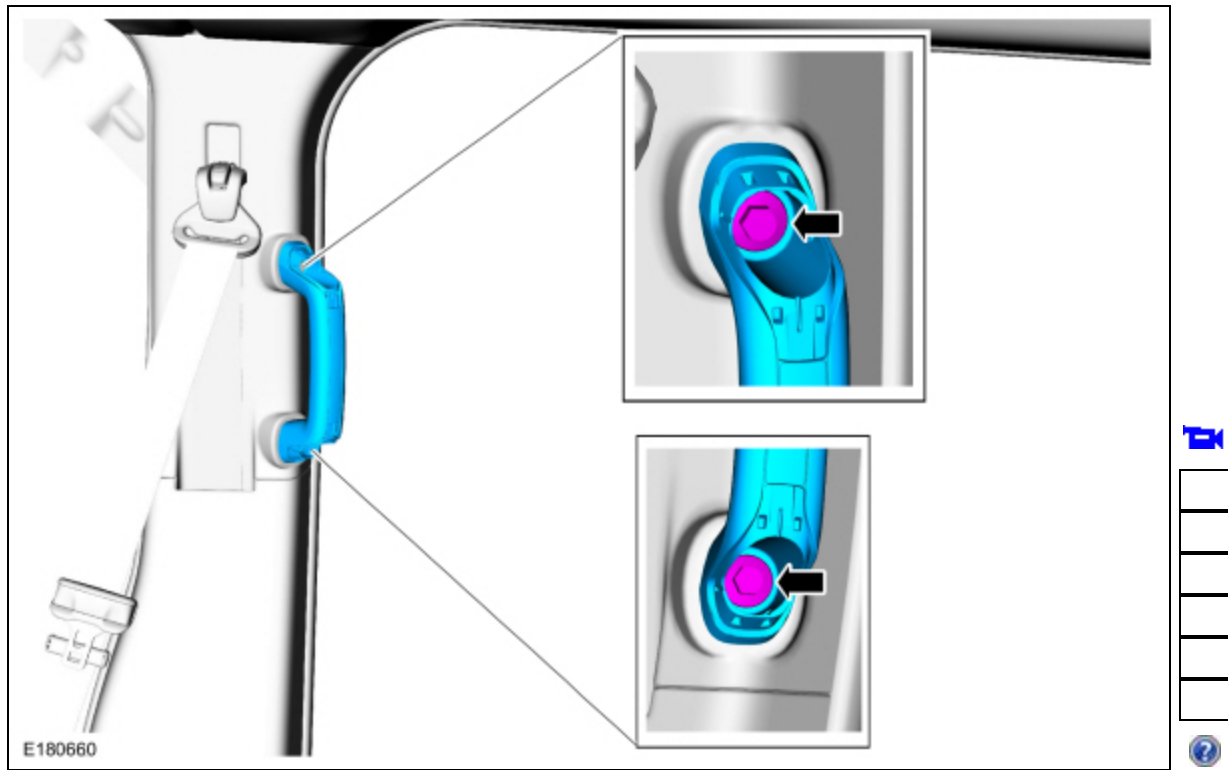

6. On passenger side.
Position aside the side door weatherstrip, release the clips, slide up and remove the middle B-pillar trim panel.
Torque: 93 lb.in (10.5 Nm)

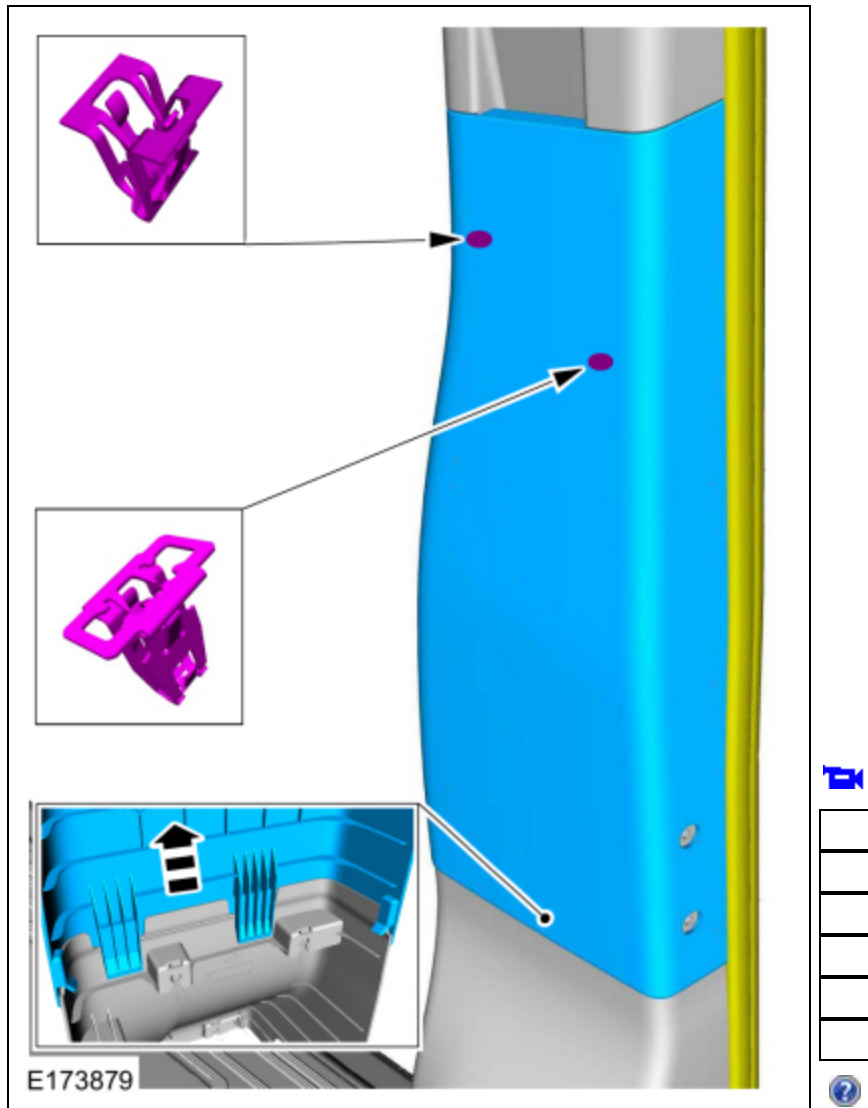

7. NOTE: *LH side shown, RH side similar.*

On both sides.

Remove the upper B-pillar trim panel.

1. Remove the upper B-pillar trim panel bolt.
Torque: 106 lb.in (12 Nm)
2. Release the clips.

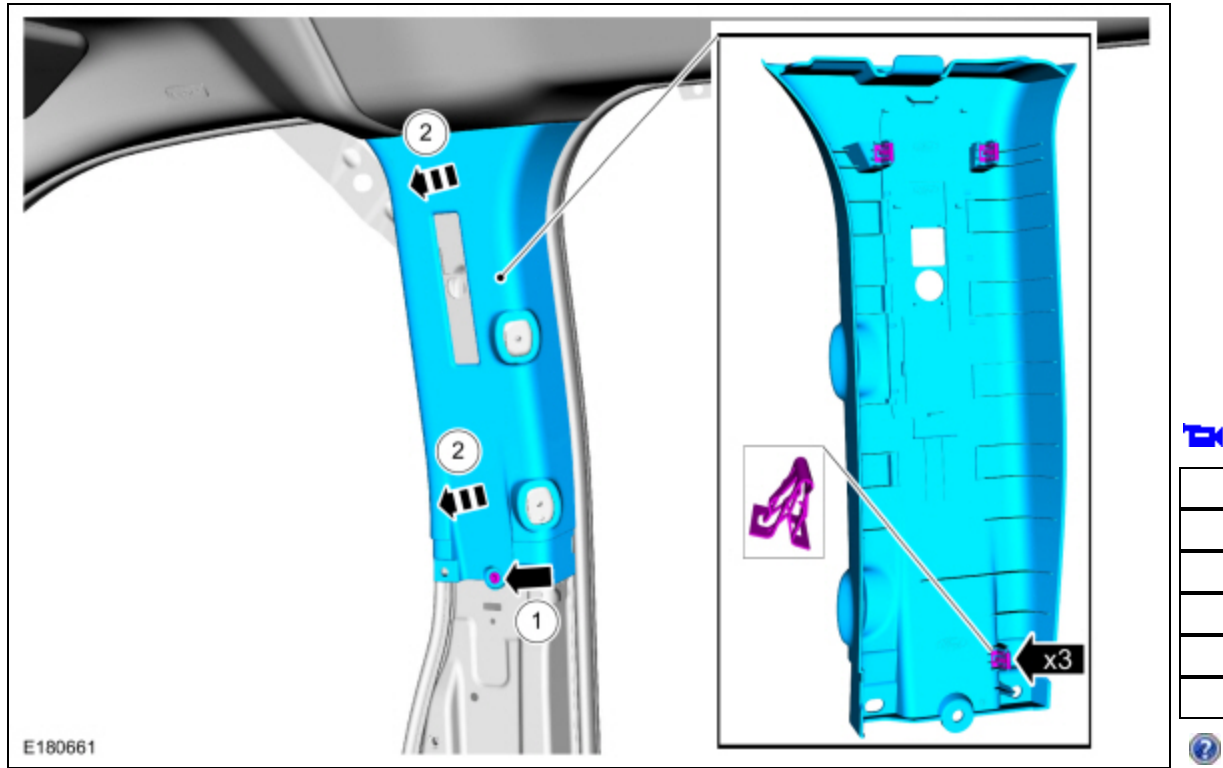

Vehicles with low roof

8. **NOTE:** LH side shown, RH side similar.

On both sides.

Remove the sun visor.

1. Remove the sun visor bolt cover.
2. Remove the sun visor screw.
3. Rotate the sun visor down.
4. If equipped.
Disconnect the sun visor electrical connector.

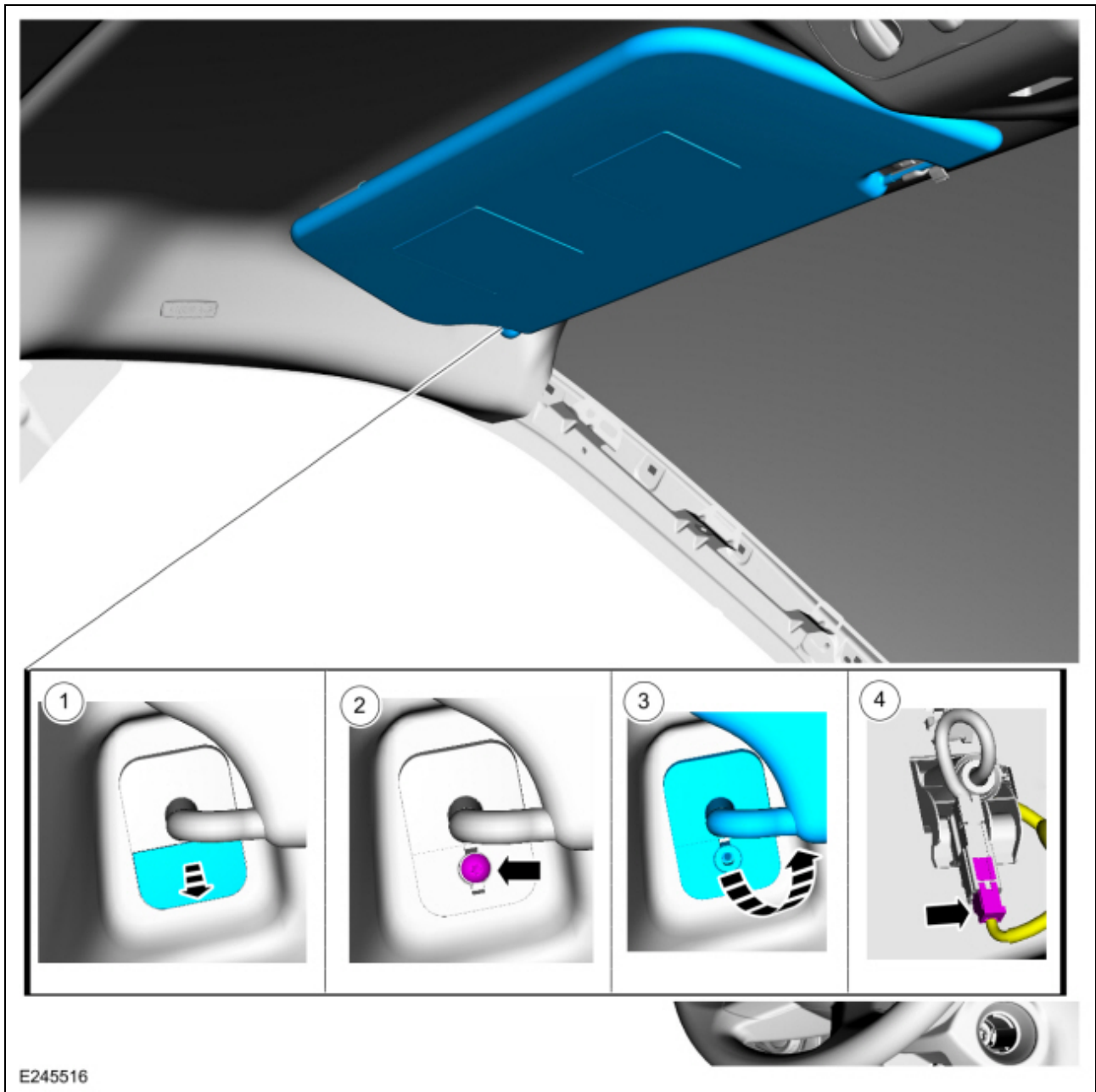

- 9. On both sides.
Remove the screw and the sun visor clip.

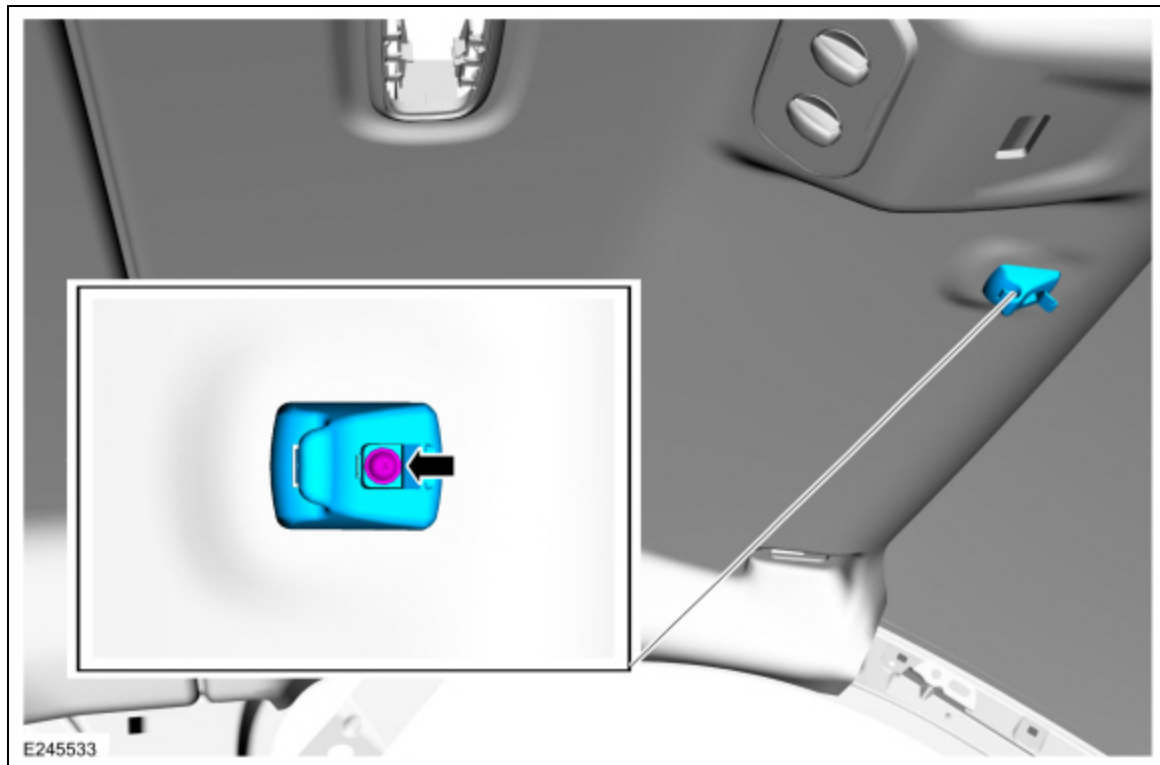

All vehicles

10. **NOTE:** *Low roof van shown, others are similar.*

1. Separate the IPMA trim cover.
Use the General Equipment: Interior Trim Remover
2. Remove the LH IPMA trim cover.
3. Remove the RH IPMA trim cover.

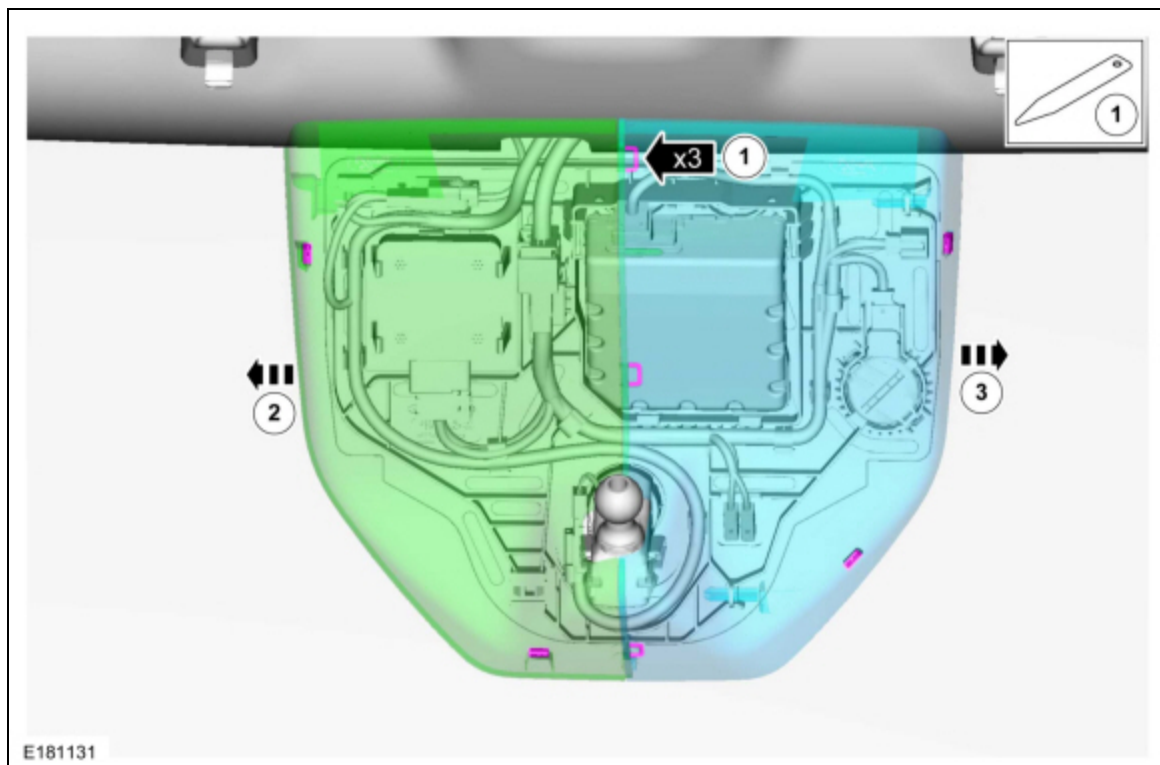

Vehicles equipped with side cargo doors

11. Position the striker cover bolt covers down.

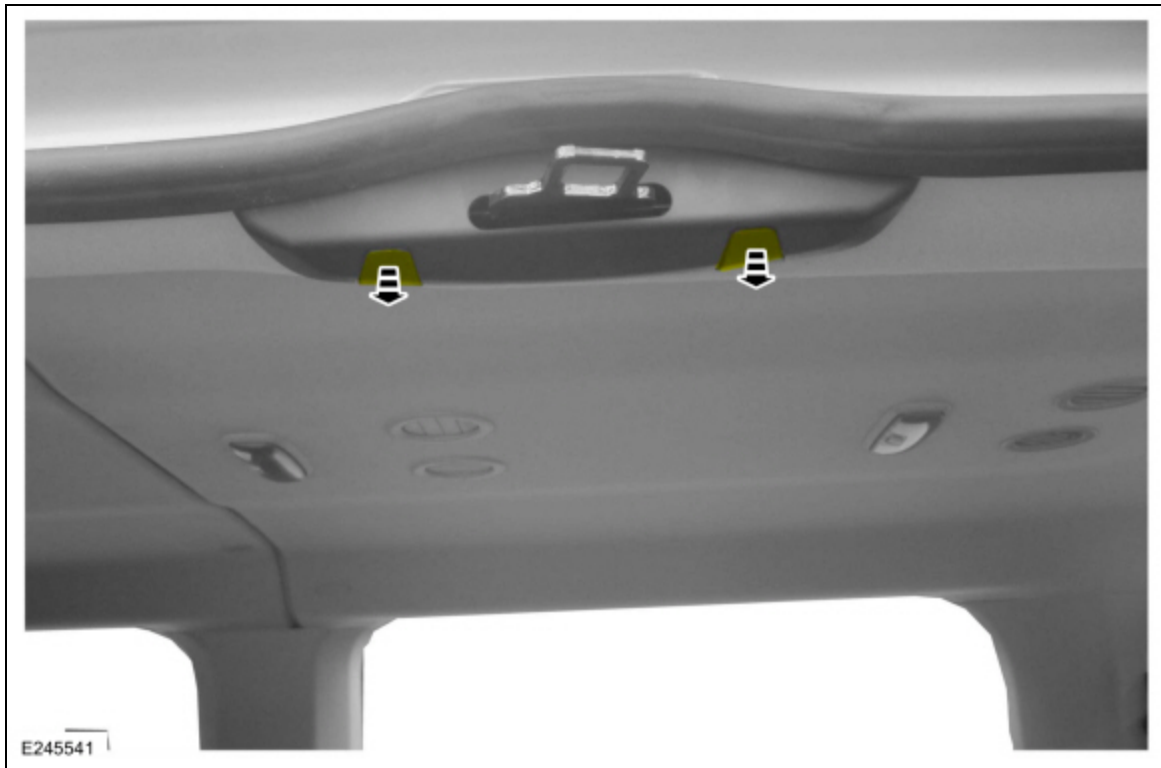

12. Remove the bolts and the striker cover.

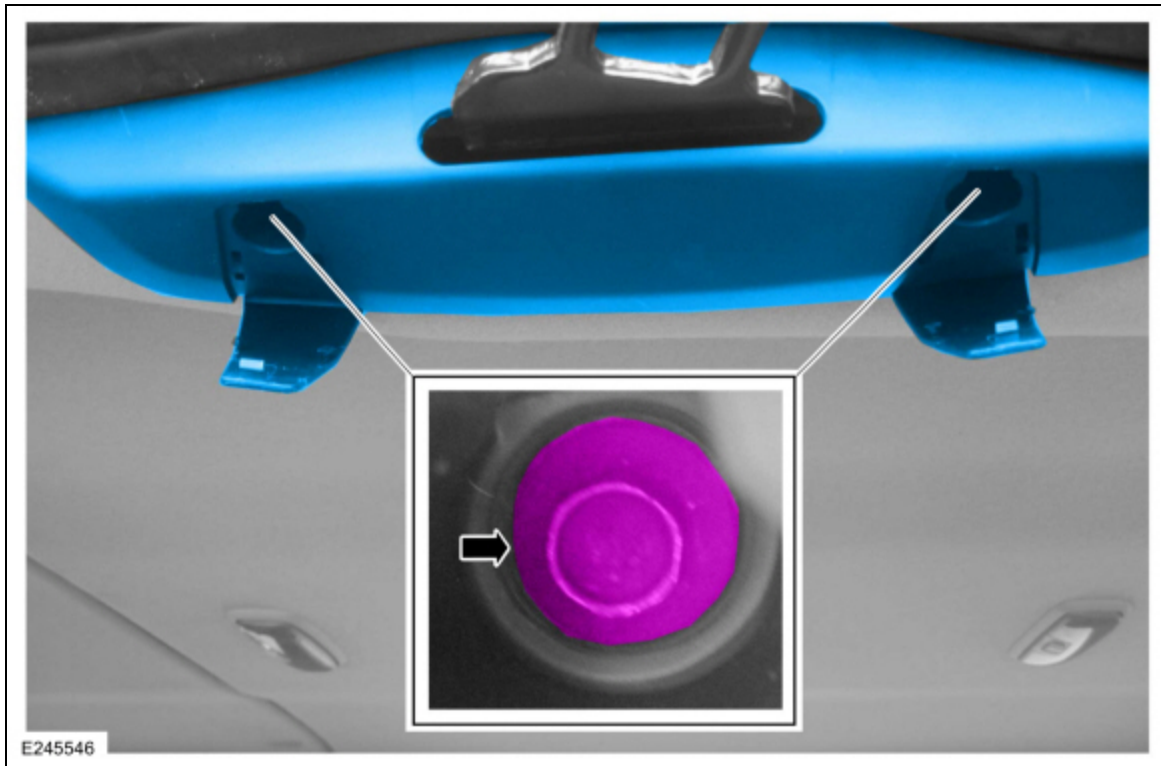

Vehicles with medium and high roof

13. If equipped.
Remove the overhead console.

M2 Bus

- 14.
 - 1. Position the sliding door weatherstrip aside.
 - 2. Release the clips and position the rear headliner section down.

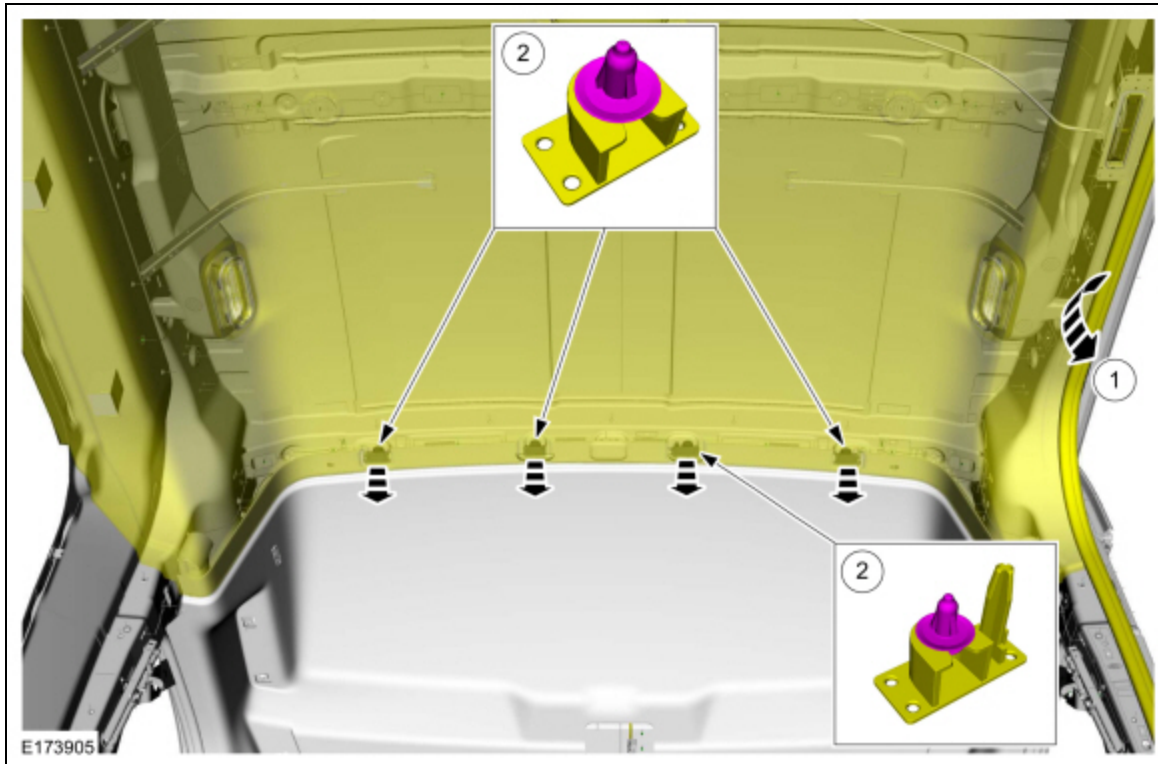

All vehicles

- 15.
 - 1. On both sides.
 - Position the front door weatherstrip aside.
 - 2. Release the front headliner rear clip.
 - 3. Release the front headliner front clip.

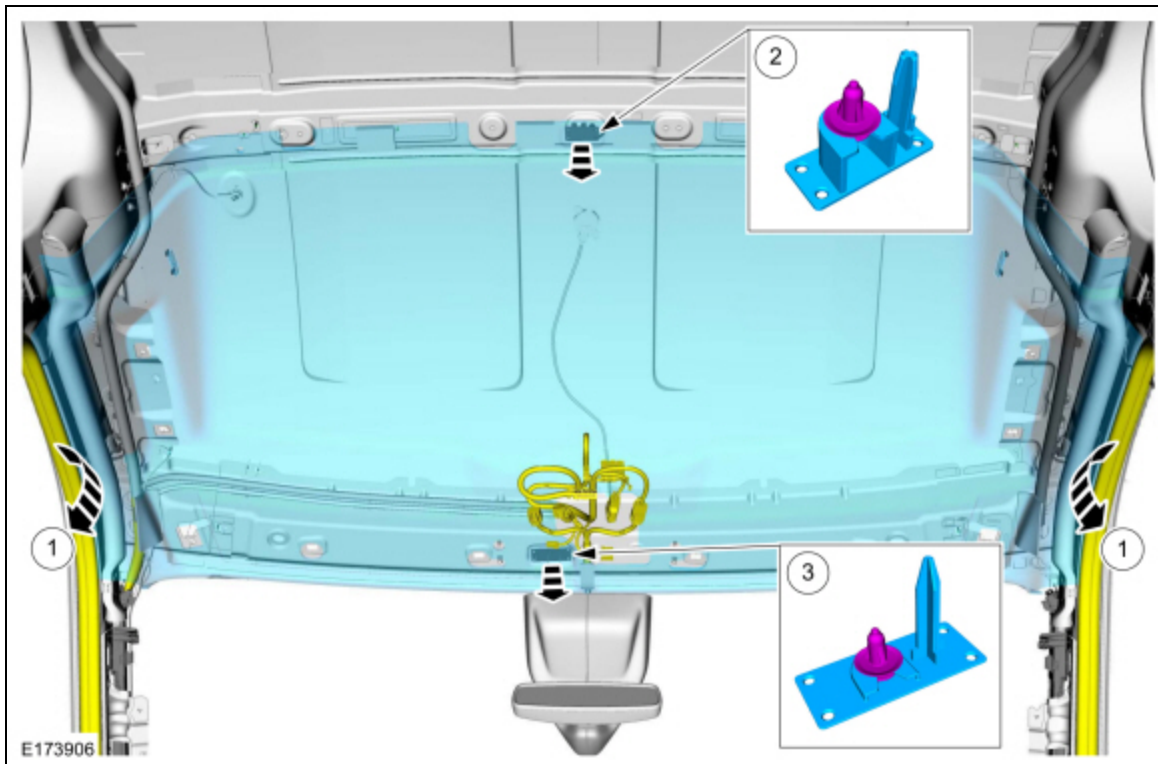

- 16. Remove the front headliner through the passenger front door.

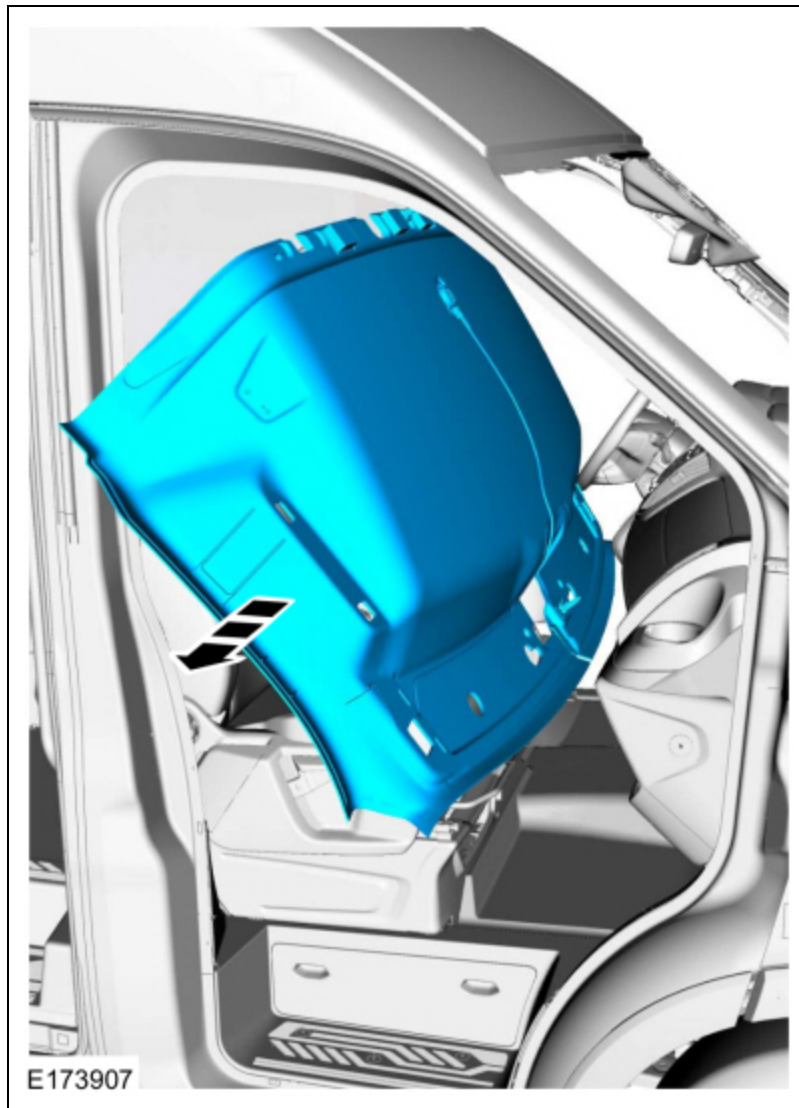

Installation

1. **NOTE:** These steps are only necessary when installing a new component.

NOTE: When transferring the headliner harness to a new headliner note the location of each electrical connector during removal and maintain those locations when transferring the harness. If equipped with noise cancellation the microphone connectors are the same but are not interchangeable and must maintain their original locations for the system to operate correctly.

NOTE: Obtain the specified adhesive commercially. Depending on the headliner and optional wiring harness(es), the purchase of multiple tubes is suggested.

1. Using tape, mark the wire at the exit points for proper length from headliner-to-body / roof connectors.
2. Carefully remove the wiring harness from the original headliner.
3. Using a marking tool, mark the new headliner with the routing and exit points of the wiring harness from the original headliner.
4. **NOTICE:** Make sure not to damage the wiring harness when cutting the excess adhesive from the wiring harness.

Cut and remove any excess adhesive from the wiring harness.
5. Position the wiring harness onto the new headliner, making sure the harness has enough length to be connected to the body / roof connectors at the tape location(s) applied earlier. Apply tape to temporarily hold the wiring harness in position on the headliner.
6. Apply the adhesive in the same location as the factory installed adhesive along the full length of the wiring harness-to-headliner to avoid any NVH concern(s).
Material: 3M™ Super-Fast Repair Adhesive / 04747

2. **NOTE:** *Transfer parts as necessary.*

NOTE: *During installation, make sure the seatbelt webbing is not twisted and seatbelts and buckles are accessible to the occupants.*

To install, reverse the removal procedure.

3. Check the active restraints system for correct operation.

Refer to: [Seatbelt Systems](#) (501-20A Seatbelt Systems, Diagnosis and Testing).

© Copyright 2024, Ford Motor Company.
